

NVE

National Vacuum Equipment, Inc.

Owner's Manual & Operating Instructions

MEC 5000/P MEC 6500/P MEC 8000/P

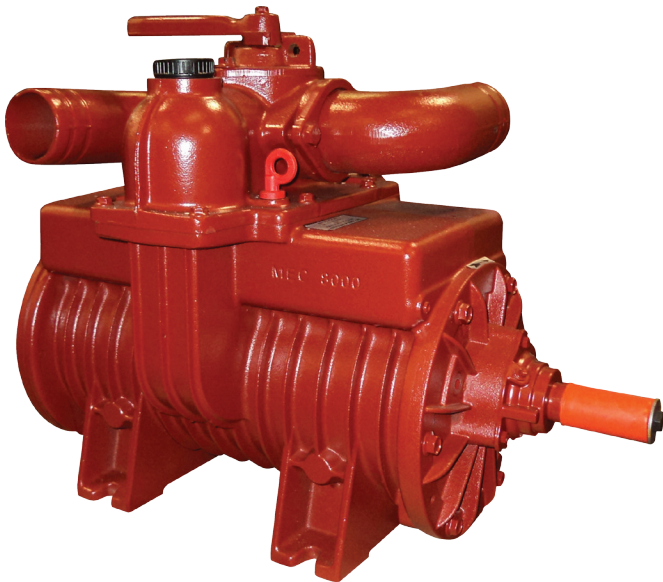

800.253.5500 | www.natvac.com

© 2009 National Vacuum Equipment, Inc.
Revision 1 (release)
June 2010

No part of this manual may be reproduced without the written permission
of National Vacuum Equipment, Inc.

MEC 5000/P
MEC 6500/P
MEC 8000/P

Owner's Record

Date of Purchase: _____

Purchased from: _____

Serial Number: _____

CONTENTS

Introduction

About National Vacuum Equipment, Inc.	5
-----------------------------------------------	---

Limited Warranty

Warranty.	6
Warranty Procedures.	8

The MEC Series Pumps

Pump Specifications	10
Performance	11
System Requirements.	12

Operating Instructions

Installation	13
Lubrication procedure	14
Automatic oil pump	14
Adjusting the automatic oil pump	15
Recommended lubrication	16
Normal operation for air cooled pumps.	16
Maintenance	17
Determining the rotation of the pump	18

Troubleshooting

Pump overheats	19
Too much oil use	19
Pump doesn't turn.	19
No vacuum or pressure in tank	19

Pump Rebuilding

Vane replacement	20
Complete rebuild	26

Parts List - MEC /P Series Pumps

Parts List	32
Parts Diagram	34
Ballast Check Valve Parts List	35
Ballast Check Valve Diagram	35

Parts Details - Lubrication Systems

Automatic Lubrication System	36
Automatic Oil Pump	40
Gear-Type Lubrication System	42

INTRODUCTION

General Information



About National Vacuum Equipment

Congratulations! You now own a quality vacuum/pressure pump proudly manufactured in the U.S.A. by National Vacuum Equipment, Inc. You have not only acquired a superior piece of equipment from a qualified dealer, you have hired a team of vacuum experts. We stand ready to work with your dealer to answer your questions and provide you with the information necessary to keep your equipment in peak working condition.

Thank you for using National Vacuum Equipment.

Our Mission

NVE is dedicated to the manufacture and wholesale distribution of quality vacuum system products at a reasonable price and delivered on a timely basis. NVE is a “one-stop shop” for manufacturers and distributors of vacuum equipment.

Our History

National Vacuum Equipment, Inc. was founded in 1980 by Bruce Luoma. NVE started as a retailer of vacuum pumps. Soon after it started, NVE secured the rights to exclusive distribution of the Battioni vacuum pumps in North America. This allowed NVE to evolve into its current status as a wholesale supplier.

To reach the goal of becoming a full service supplier of vacuum system components, NVE began fabrication its own line of componentry, purchased and developed its own line of vacuum pumps, and began purchasing for resale various valves and accessories.

Today, NVE has full service machine, fabrication and powder-coating shops complete with CNC-controlled production equipment designed for close tolerance work. Our staff is highly trained and are committed to quality from start to finish.

LIMITED WARRANTY

Warranty

National Vacuum Equipment, Inc. guarantees that the product it provides is free of manufacturer's defects, including materials and workmanship. Properly installed and maintained product is warranted for a period of one (1) year subject to the following conditions:

1. A properly completed warranty registration card must be received by us within 30 days of sale to end user for pump sales to be considered warrantable. All pumps received for warranty consideration must retain the original NVE serial number tag.
2. The one (1) year period shall begin the day the product is shipped from our warehouse, unless we are provided with an authentic copy of the original resale invoice, in which case the one (1) year period shall begin at such invoice date.
3. The covered product must be used in an application for which it was intended. We do not recommend our product for particular uses or applications.
4. Vane breakage, or damage caused by vane breakage, is not warrantable.
5. Damage caused by improper use or lack of proper maintenance is not warrantable.
6. Manufacturer's liability under this or any other warranty, whether express or implied, is limited to repair of or, at the manufacturer's option, replacement of parts which are shown to have been defective when shipped.

7. Manufacturer's liability shall not be enforceable for any product until National Vacuum Equipment, Inc. has been paid in full for such product.

8. Except to the extent expressly stated herein, manufacturer's liability for incidental and consequential damage is hereby excluded to the full extent permitted by law.

9. Manufacturer's liability as stated herein cannot be altered except in writing signed by an officer of National Vacuum Equipment, Inc.

10. Certain products provided by National Vacuum Equipment, Inc. are covered by their respective manufacturer's warranties (e.g., engines used in the NVE engine drive packages). These products are not covered by the National Vacuum Equipment, Inc. Manufacturer's Warranty.

11. Final assemblers responsibility. NVE goes to great lengths to insure the quality and proper functionality of the products it supplies. Many products we supply are purchased for resale or are impossible or impractical to test prior to the installation of the item in a vacuum system. It is therefore the responsibility of the final assembler to thoroughly test the vacuum system and components supplied to the assembler by NVE prior to the delivery of the final product to the end user.

Any items found to be defective after delivery to the end user that should have been discovered prior to delivery will qualify replacement of the defective part only with absolutely no compensation for outside labor or travel expenses. Any subsequent damage to other components caused by the defective part will be the sole responsibility of the assembler.

WARRANTY PROCEDURES

Should a potential warranty situation arise, the following procedures must be followed:

- Contact your dealer immediately upon the occurrence of the event and within the warranty period.
- Customer must receive a return goods authorization (RGA) before returning product.
- All serial-numbered products must retain the NVE serial number tag to be qualified for warranty.
- Product must be returned to NVE intact for inspection before warranty will be honored.
- Product must be returned to NVE freight prepaid in the most economical way.
- Credit will be issued for material found to be defective upon our inspection, based upon prices at the time of purchase.

The MEC Series Pumps

*Model-Specific Information
for the
MEC 5000/P
MEC 6500/P
MEC 8000/P*

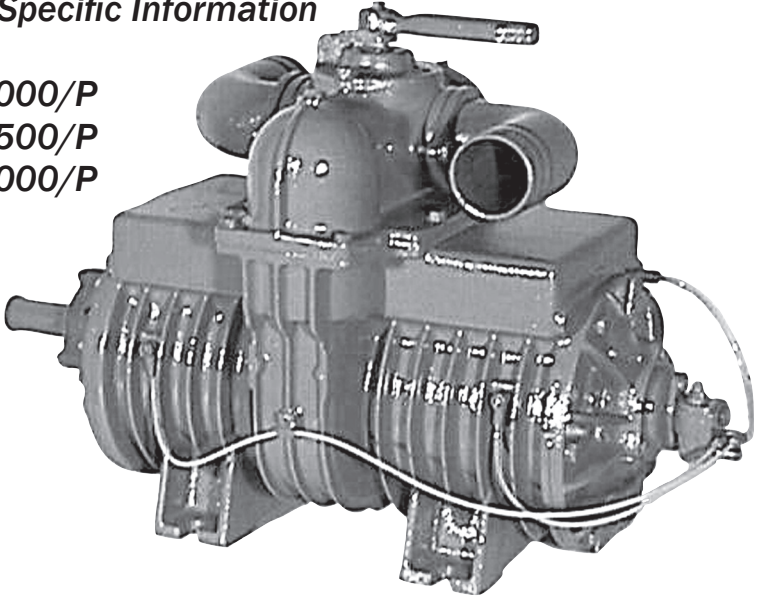

MEC Series Pump Specifications

<u>Model Number</u>	<u>5000</u>	<u>6500</u>	<u>8000</u>
RPM Range	800-1400	800-1400	800-1400
Max. Air Flow-CFM	195	250	285
Max. Intermittent Vacuum	27	27	27
Max. Intermittent Pressure	30	30	30
Pump Drive Rotation	CW/CCW	CW/CCW	CW/CCW
Porting Size	3 inch	3 inch	3 inch
Manifold With Four Way Valve	Std	Std	Std
Oil Tank Capacity-Quarts	2 1/2	3 1/4	4
Bearings Sealed From Pump Interior	Std	Std	Std
Anti-Spin Check Valve	Std	Std	Std
Automatic Lubrication System	Opt	Opt	Opt
Net Weight	308	343	400

MEC 5000/P PERFORMANCE

		PRESSURE PSI							VACUUM – INCHES OF MERCURY								
RPM		30	25	20	15	10	5	0	3	6	9	12	15	18	21	24	27
1400	HP	28	24	21	17	14	12	7	7	7	8	9	10	11	12	13	14
	CFM	154	158	166	172	180	187	195	192	190	185	180	175	165	155	140	115
1200	HP	24	20	17	15	13	8	5	6	6	7	7	8	9	10	11	12
	CFM	128	132	138	144	150	158	165	162	160	156	152	148	140	130	115	85
1000	H.P	19	17	14	12	9	6	3	4	4	5	6	7	7	8	9	9
	CFM	98	106	112	117	124	130	138	135	130	126	121	116	110	98	84	50

MEC 6500/P PERFORMANCE

		PRESSURE PSI							VACUUM – INCHES OF MERCURY								
RPM		30	25	20	15	10	5	0	3	6	9	12	15	18	21	24	27
1400	HP	34	30	27	22	18	13	10	10	11	11	12	12	13	13	14	15
	CFM	220	224	228	232	237	242	250	248	246	244	240	236	230	220	205	180
1200	HP	28	26	22	18	14	12	8	8	9	9	10	11	11	12	12	13
	CFM	184	188	192	197	204	212	220	218	216	214	210	202	196	185	175	145
1000	H.P	24	22	18	15	12	8	6	6	7	7	8	8	9	10	10	11
	CFM	152	156	160	163	167	170	180	177	172	170	167	162	158	150	140	110

MEC 8000/P PERFORMANCE

		PRESSURE PSI							VACUUM – INCHES OF MERCURY								
RPM		30	25	20	15	10	5	0	3	6	9	12	15	18	21	24	27
1400	HP	42	37	33	27	22	17	12	12	13	14	15	17	18	19	20	21
	CFM	248	251	255	260	268	278	285	282	280	277	271	265	258	242	220	180
1200	HP	35	32	28	22	16	12	8	9	10	11	11	12	13	14	15	16
	CFM	206	210	214	220	230	237	245	243	240	236	230	225	218	200	180	150
1000	H.P	29	25	21	17	13	9	6	6	7	7	8	9	10	11	12	13
	CFM	168	173	178	183	190	195	200	205	200	192	186	180	170	158	146	100



Recommended Setup
for optimum performance

System requirements

High quality components

- The pump body and rotor are constructed of cast iron with free sliding vanes made of special nonmetallic, heat resistant material.
- Because vanes are nonmetallic, flammable fluids may be handled without danger.
- Vanes wear evenly because tips always remain in contact with the wall surface.
- For maximum life and proper performance we recommend the use of our compatible components, Portal F-801 and Moisture Trap F-901.

Operating Instructions

MEC 5000/P
MEC 6500/P
MEC 8000/P

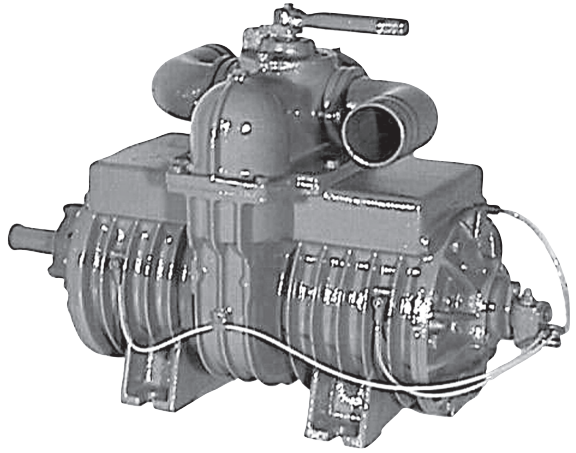

Installation

- Check pump rotation. See **Determining the Rotation of Pump.**
- Pump should always be mounted in a level, horizontal position on a firm, flat surface.
- Grade 5 bolts should be used in installation. It is important to use flat washers and lock washers.
- We recommend the use of oil resistant hose on both the inlet and outlet sides of the pump. If using direct drive system, always use a flexible coupling. We recommend the use of Woods Sure Flex Couplers.
- If a muffler is used on discharge side of pump, inlet and outlet of muffler must be at least equal to inside diameter of pump outlet.

Lubrication procedure for all vacuum pumps on start up (This procedure must be followed prior to the operation of a new vacuum pump.):

- With force feed lubrication type, install dripper on top of pump and connect rubber lines.*
- Remove dipstick and fill oil reservoir with recommended turbine oil.
- With 540 RPM pumps: fill gear housing to level of clear plastic sight plug on the side of the housing with SAE 90 gear oil.
- Remove plastic cap on air inlet and pour 2 oz. turbine oil into pump. Start pump slowly and with valve in suction position, pour 2 oz. turbine oil into air inlet.
- At this point oil should be visible in the dripper or oil lines. Adjust dripper flow to 1 drop every 2 seconds.

***Dripper will be shipped loose or taped to the bottom of the changeover valve handle.**

Automatic oil pump

- The automatic oil pumps are set at the factory during pump testing and should require no further adjustment during pump installation.
- The pumps are adjusted to one drop every two seconds per outlet. This oil rate equals 2.7 fluid oz. per hour.

Adjusting the automatic oil pump

The automatic oil pump is a metered piston-type pump.

If you wish to adjust the pump, please follow these instructions:

Adjusting the oil rate

Oil flow is changed by adjusting the length of the stroke of the piston.

1. To adjust the oil rate, remove cap #P16. Under this cap you will find a jam nut #P15 and adjusting screw #P11.
2. To adjust oil rate loosen jam nut and turn adjusting screw clockwise to reduce oil flow or counterclockwise to increase oil flow.
3. When making adjustments do so one turn of the screw at a time and test before making further adjustments.
4. Be careful to not turn adjusting screw too far counterclockwise as you may disengage the gears and strip them out.

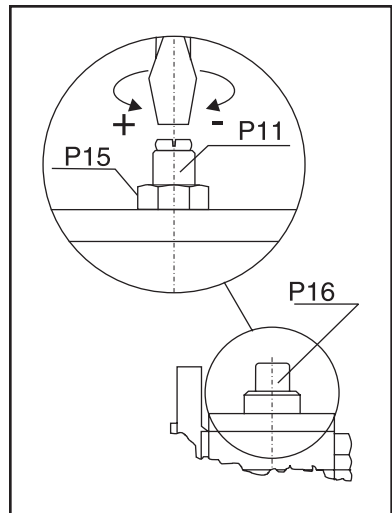

Testing flow rate after adjustment

1. Observe oil drip rate in oil view meter or oil line to ensure adequate lubrication.
2. Adjustments should be done gradually so as not to starve the vacuum pump of oil.

Recommended lubrication

We recommend that turbine grade oil be used in all our pumps. Turbine oil is more highly refined than motor oil and is much less likely to create carbon. Turbine oil is available from your local oil distributor. Below is a list of acceptable oils.

- Penzoil Penzabell 68 T.O.
- Shell Turbo 68
- Mobil D.T.E. Heavy – Medium
- Texaco Regal R.N.O. 68

Normal operation for air cooled pumps:

1. Check oil reservoir daily and fill as required.
2. When pump is in operation check oiler to insure flow of oil to pump.
3. Do not operate pump faster than recommended RPM.
4. To operate suction valve on top of pump, move handle in the appropriate direction for either vacuum or pressure; center it for neutral.
5. We recommend checking vane wear every twelve months. A new vane is nearly flush with the rotor. Measure the wear and if is over 1/4" we recommend replacing vanes. It's good to always keep a spare set of vanes on hand for emergencies.

Maintenance

- With force feed type, the lubrication rate is adjustable at dripper and should be checked on a regular basis. Oil should be supplied to pump at a rate of 1 drop every 2 seconds.
- Average usage of oil is approximately 1-2 qts. per 40 hours, depending on operation.
- Oil should be changed every 2000 hours in gear per housing, if equipped.
- Front bearing should be greased approximately every 4 months. Use caution when greasing bearing not to over grease, as this can cause damage to seals.
- Normal vane life is approximately 2000 hours; however, this will vary greatly with temperature, material being pumped and proper maintenance.
- Occasionally liquid and dirt may enter the pump causing vanes to stick in the rotor slots along with excessive vane and housing wear. When this occurs you must clean the inside of the pump.

Cleaning the inside of the pump

- Remove air inlet hose or pressure relief valve.
- Run pump at an idle with the changeover valve in neutral.
- Pour 1 pint of diesel fuel into pump through the air inlet or fitting. Allow pump to run for 30 seconds then turn the change over valve to vacuum.
- Repeat two steps above several times, and then pour 2 oz. of oil into the pump and reassemble.
- *Stop pump and turn slowly by hand while listening for vanes dropping. All vanes should move freely in the rotor slot.*

- It is good practice to clean your pump on a regular basis as this will normally increase the life of your pump greatly.
- Vane wear should be checked every 12 months. A new vane will be flush with the outside diameter of the rotor.
- When vane wear exceeds 1/4" the vanes should be replaced. It is a good idea to have an extra set of vanes, seals and gaskets on hand at all times.

Determining the rotation of the pump

As one faces the drive end of the pump:

- For 1000 RPM pumps with the oiler on the right side, the pump shaft turns clockwise.
- For gear driven pumps (540 RPM) with the oiler on the right side, the pump shaft turns counterclockwise.
- If you must change the rotation of your pump contact the factory for instructions before attempting it.

Troubleshooting

MEC 5000/P
MEC 6500/P
MEC 8000/P

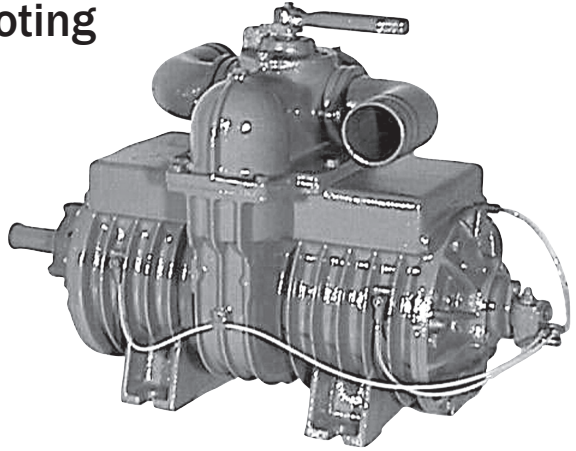

Pump overheats

- No oil in pump
- Oil adjustment set too lean
- Rpm too fast
- Prolonged operation

Too much oil use

- Oil adjustment set too rich
- Oil seals defective
- Cracked pump body

Pump doesn't turn

- Broken vane
- Frozen
- Pump endplate bolts too tight
- Faulty PTO or drive set up

No vacuum or pressure in tank

- Suction valve in neutral
- Defective seal or vanes
- Pump not driven fast enough
- Check valve or suction line clogged
- Leak in tank or fittings

Pump Rebuilding

MEC 5000/P
MEC 6500/P
MEC 8000/P

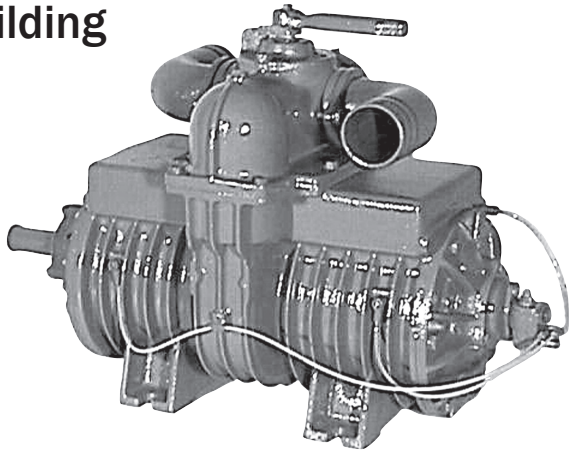

Please read these instructions completely before attempting repair.

Vane replacement

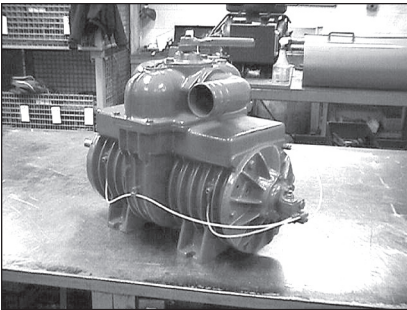

1. Clean off the exterior of the pump.

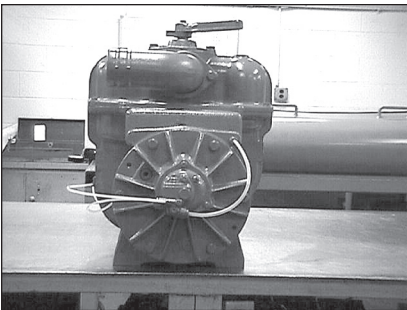

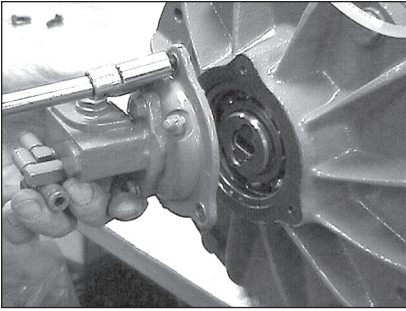

2. Remove the 3 6x20mm screws attaching the oil pump assembly to the vacuum pump.

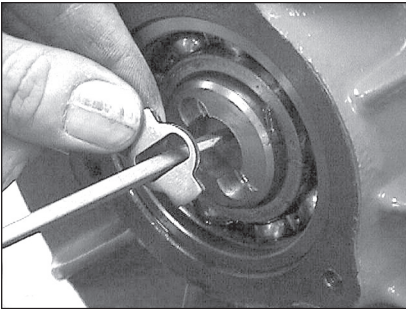

3. Remove the oil pump drive key from the end of the rotor.

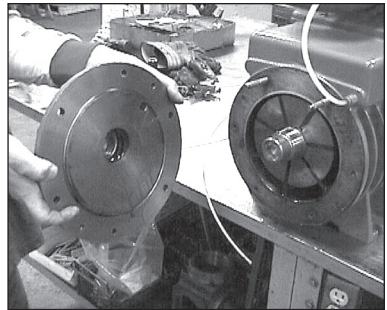
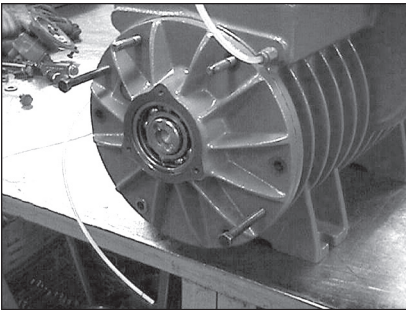

4. Remove the six bolts that attach the endplate to the pump.

Secure two 10x50mm bolts to screw into pull holes.

Screw the bolts into the pull holes evenly and pull off the endplate.

If you cannot locate 10x50mm bolts, you can use the endplate bolts and shim behind the endplate as the endplate comes off.

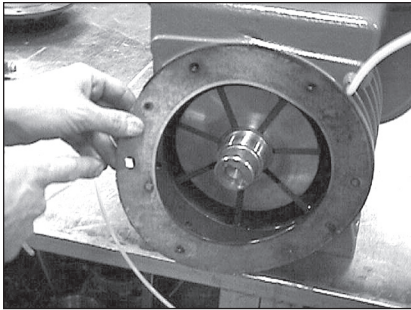

5. Note the number of gaskets on the endplate. You must use the same number of gaskets during reassembly.

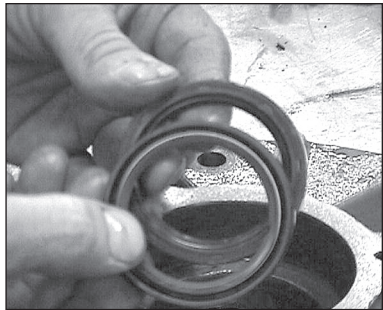
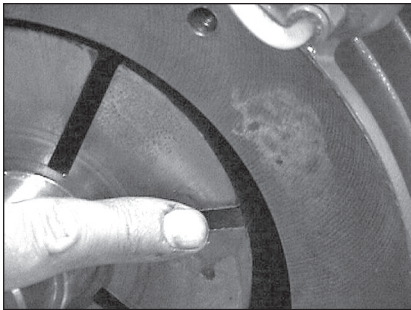

6. Inspect vanes, bearings and seals and replace as necessary.

A new vane is flush with the outside diameter of the rotor.

If they are worn more than 1/4" they should be replaced.

We recommend replacing vanes in sets.

If the ends of the vanes are chipped or delaminated they should be replaced.

The seals should be soft and pliable.

The bearing should turn smoothly.

7. Clean the rotor, rotor slots and housing and inspect for wear or damage.

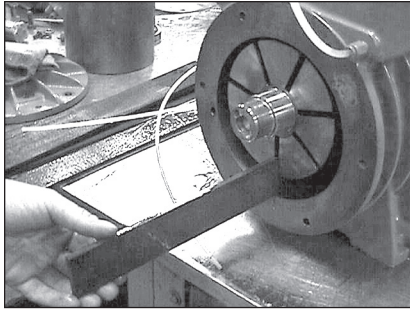

8. Coat the housing and vanes with oil and install the vanes in the rotor. The vanes should slide freely in the vane slot.

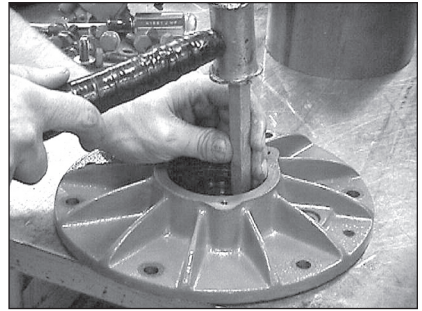
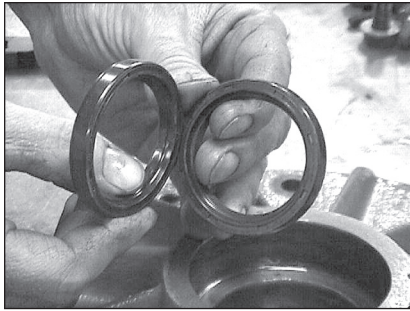

9. Locate the replacement seals and install them in the endplate with the seals positioned back to back.

10. Lubricate and install the bearing in the endplate.



11. Locate the proper number of gaskets and install them on the endplate.

Do not use any gasket sealer.

Locate the two 10x50mm bolts used for pulling the endplate and insert them in bolt holes on either side of the endplate to capture the gasket.

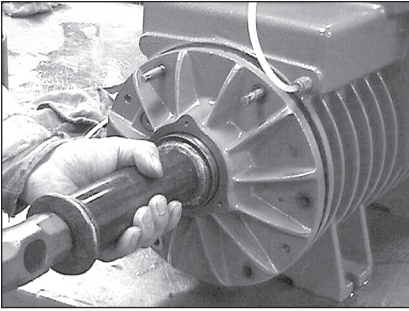

12. Lubricate seal sleeve and install the endplate on the end of the rotor and carefully drive the endplate on the rotor.

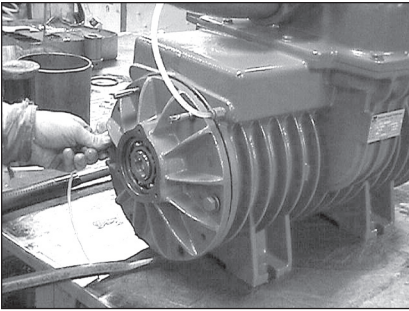

13. When the endplate is close enough to the housing install the endplate bolts lift the endplate-rotor assembly to allow proper alignment of the bolts and bolt holes and start the bolts into the housing.

Just prior to making contact with the housing, lift the endplate -rotor assembly again to insure proper clearance between the rotor and the housing.

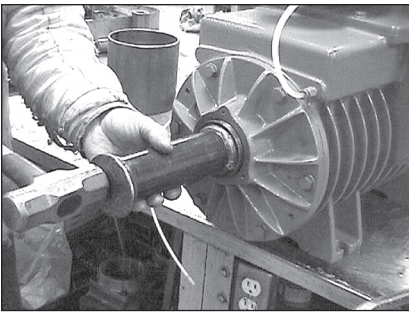

Tighten endplate bolts to 35-40 ft lb of torque.

14. Seat the bearing with a bearing driver or punch.

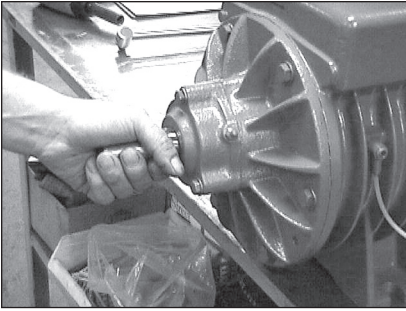

15. At this point you should be able to turn the pump by hand.

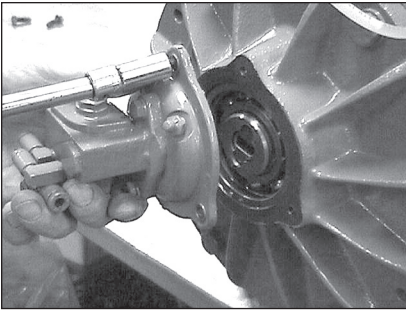

16. Reinstall the oil pump drive key and oil pump mount assembly to the pump.

Be sure to line up the oil pump drive key and the oil pump shaft prior to tightening the assembly to the pump.

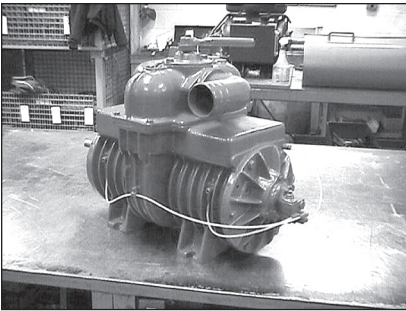

17. Connect the oil lines to the oil pump.

The pump is now ready to run.

18. Start the pump at a slow RPM and allow to run for a few minutes until oil can be seen in the lines.

The pump is *now* ready to go to work.

Complete rebuild

1. Follow steps 1-7 in the vane replacement instructions.

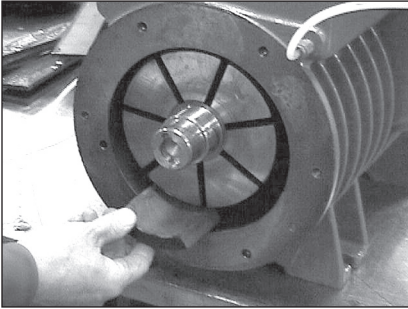

2. Place a cushion under the rotor to prevent damage when the front endplate is unbolted.

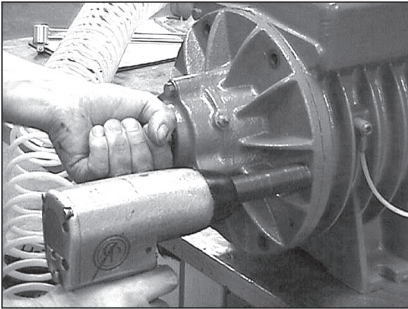

3. Remove the six bolts attaching the endplate to the housing.

Support the rotor shaft prior to loosening the last bolt.

Slide the rotor out

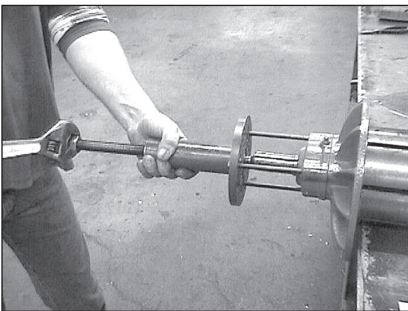

4. Remove the front endplate, front bearing and bearing cover from the rotor with a puller or hydraulic press.

Put an identifying mark on the endplate so as to not confuse it with the rear.

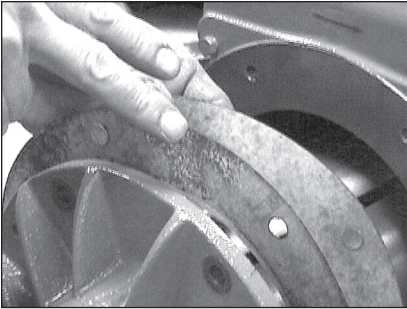

5. Count the number of gaskets.

6. Clean the rotor, rotor slots and housing and inspect for wear or damage.

If the housing needs to be bored or honed, remove only as much material as is necessary to give a smooth clean bore.

The maximum over bore we recommend is .060 inch. (A new housing has a bore of 7.095 inches.)

If you bore or hone the housing, remove the four way valve assembly and internal check valve ball prior to machining.

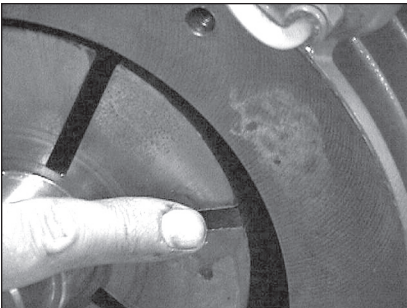

7. Inspect vanes, bearings and seals and replace as necessary.

A new vane is flush with the outside diameter of the rotor.

If they are worn more than 1/4" they should be replaced.

We recommend replacing vanes in sets.

If the ends of the vanes are chipped or delaminated they should be replaced.

The seals should be soft and pliable.

The bearing should turn smoothly.



8. Locate the replacement seals and install them in the endplates with the seals positioned back to back.

Replace the seal in the bearing cover with the lip facing outward.

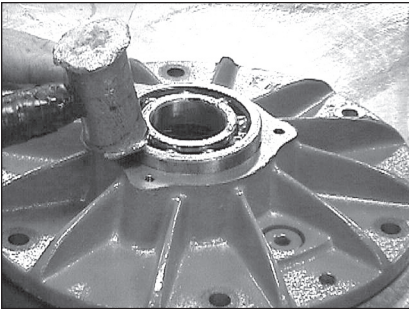

9. Lubricate and install the bearings in the endplates.

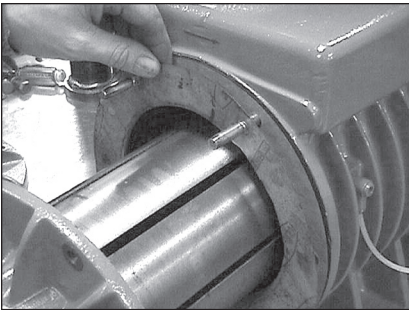

10. Locate two pieces of threaded rod 3/8-18 thd. to use as guides and screw them into the two top holes in the housing.

Locate proper number of gaskets and slide on the threaded rods.

Do not use any gasket sealer.

11. Lubricate the housing bore.

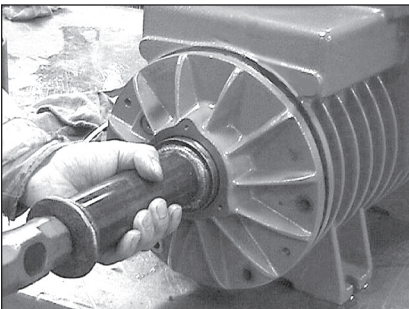

12. Lubricate seal sleeve and drive the proper endplate on the input end of the rotor.

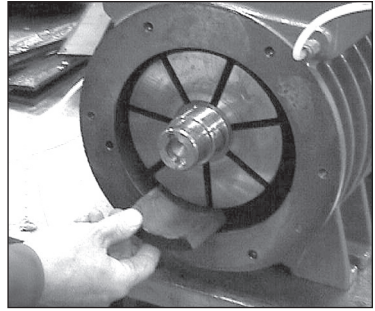
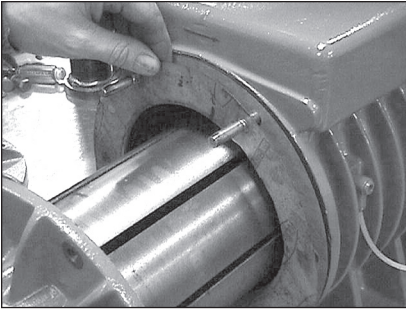

13. Slide rotor-endplate assembly into the pump housing.

Slide the cushion material used during disassembly under the rotor on the opposite end to gain leverage during assembly of endplate to housing.

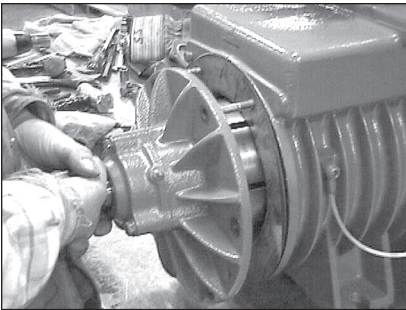

14. Lift the rotor-endplate assembly and slide over the 3/8 inch threaded guides and install the endplate bolts.

Tighten the bolts sufficiently to make contact between the endplate and the housing.

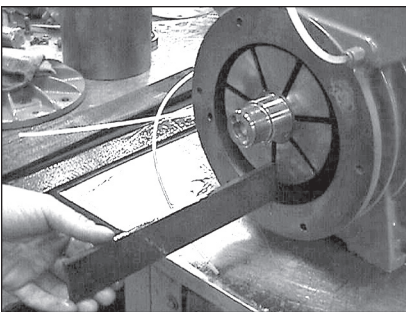

15. Coat vanes with oil and install the vanes in the rotor. The vanes should slide freely in the vane slots.

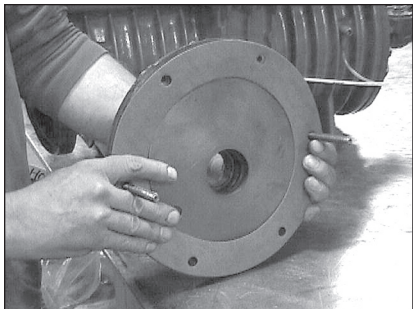

16. Locate the proper number of gaskets and install them on the rear endplate.

Do not use any gasket sealer.

Locate the two 10x50mm bolts used for pulling the endplate and insert them in bolt holes on either side of the endplate to capture the gaskets.

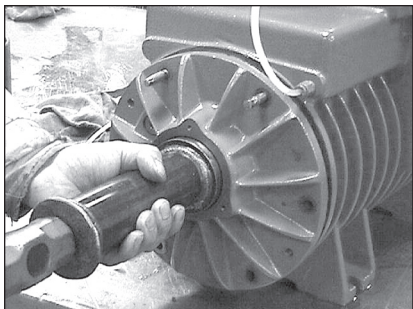

17. Lubricate seal sleeve and install the endplate on the end of the rotor and carefully drive the endplate on the rotor.

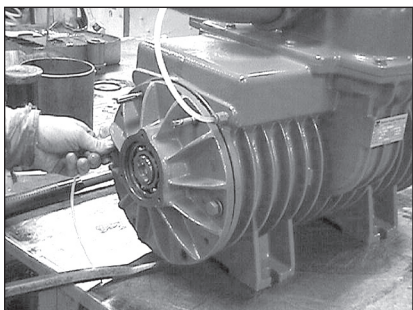

18. When the endplate is close enough to the housing install the endplate bolts lift the endplate-rotor assembly to allow proper alignment of the bolts and bolt holes and start the bolts into the housing.

Just prior to making contact with the housing, lift the endplate-rotor

assembly allow the endplate to enter the housing.

Tighten endplate bolts to the point where the endplate just touches the housing.

19. With a prybar and a block of wood, lift the endplate to make certain the seal gap is properly set and tighten the endplate bolts to 35-40 ft lb of torque.

Tighten both endplates in this manner.

20. Seat the bearings on both endplates with a bearing driver or punch.

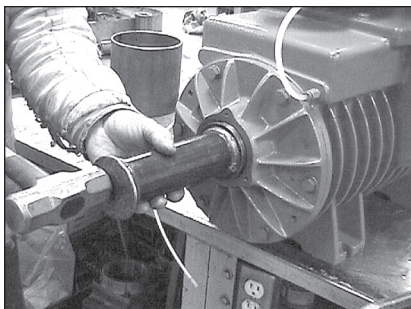

21. At this point you should be able to turn the pump by hand.

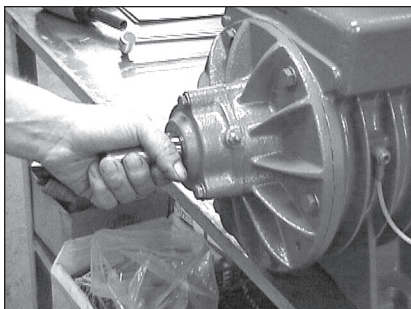

22. Lubricate and reinstall the front outboard bearing and bearing cover.

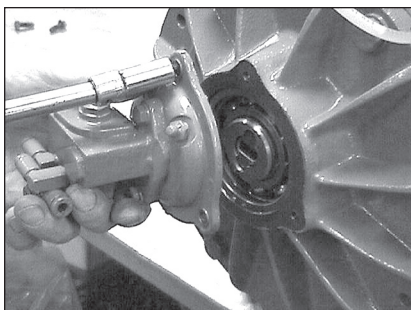

Reinstall the oil pump drive key, oil pump mount assembly, and gaskets to the pump.

Be sure to line up the oil pump drive key and the oil pump shaft prior to tightening the assembly to the pump.

23. Connect the oil lines to the oil pump.

The pump is *now* ready to run.

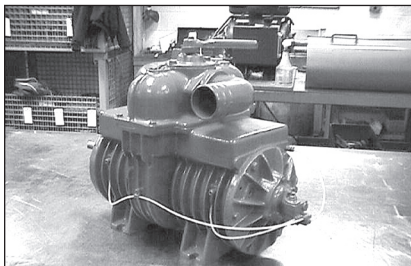

24. Start the pump at a slow RPM and allow to run for a few minutes until oil can be seen in the lines or dripper.

Allow to run for a few more minutes.

The pump is now ready to go to work.

Parts List – MEC /P Series Pumps

MEC 5000/P

MEC 6500/P

MEC 8000/P

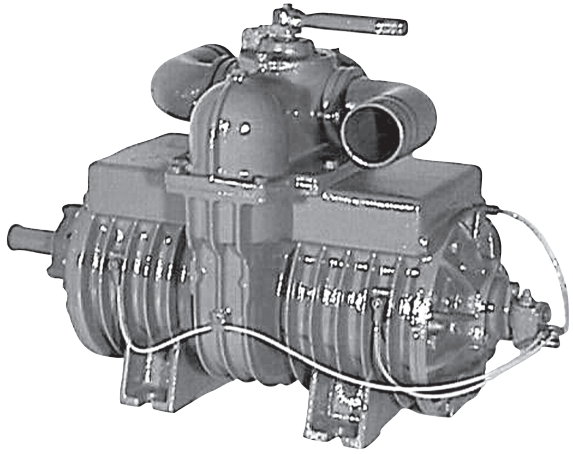

See Parts Diagram on next page.

Part #	Description
AM1	Housing - 5000
AMEC1	Housing - 6500
AME1	Housing - 8000
AM3	Rear Endplate
AM3/P	Front Endplate
AM4	Gasket
AM5/P	Rotor - 5000/P
AMEC5/P	Rotor - 6500/P
AME5/P	Rotor - 8000/P
AM7	Vane - 5000
AMEC7	Vane - 6500
AME7	Vane - 8000
AM10	Dipstick (mm .79)
AM11	Bolt (m8x20)
AM13	Gasket
AM16	Bolt (m10x30)
AM17	Washer (10)
AM18	Seal (48-62-8)
AM27	Gasket
AM34	Bolt (m8x25)
AM35	Washer (8)

Parts Diagram

MEC 5000/P

MEC 6500/P

MEC 8000/P

Parts list continued from previous page.

Part #	Description	Part #	Description
AM36	Exhaust Pipe	AM56	Bolt (m8x50)
AM39	Gasket	AM57	Spacer (80-70-5)
AM40	Seal (30-40-7)	AM59	Oil Plug
AM41	Non-Return Ball	AM60	Handle
AM45	Spring	AM62	4-way Valve Plug
AM48	Bearing (6208)	AM63	Flange
AM49	Fitting	AM64	O-Ring
AM50	Washer	AM65	4-way Valve Cover
AM51	Bolt	AM66	Bolt (m10x40)
AM52	Key	AM67	4-way Valve Housing
AM53	Seal (35-52-10)	AM68	4-way Valve Cover Gasket
AM54	Bearing Cover	AM83	3" Hose Connection
AM55	Bearing (6207)		

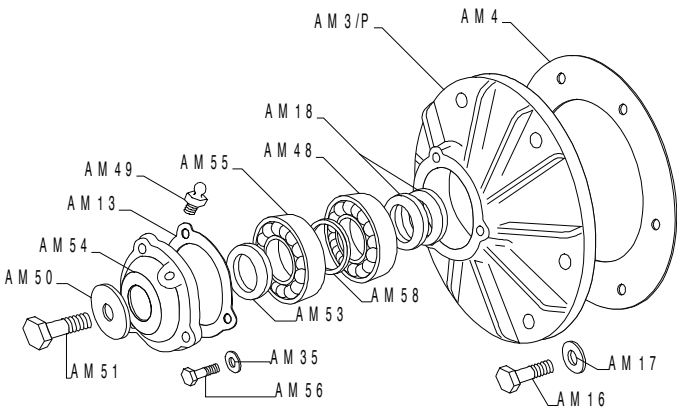

National Vacuum Equipment, Inc.

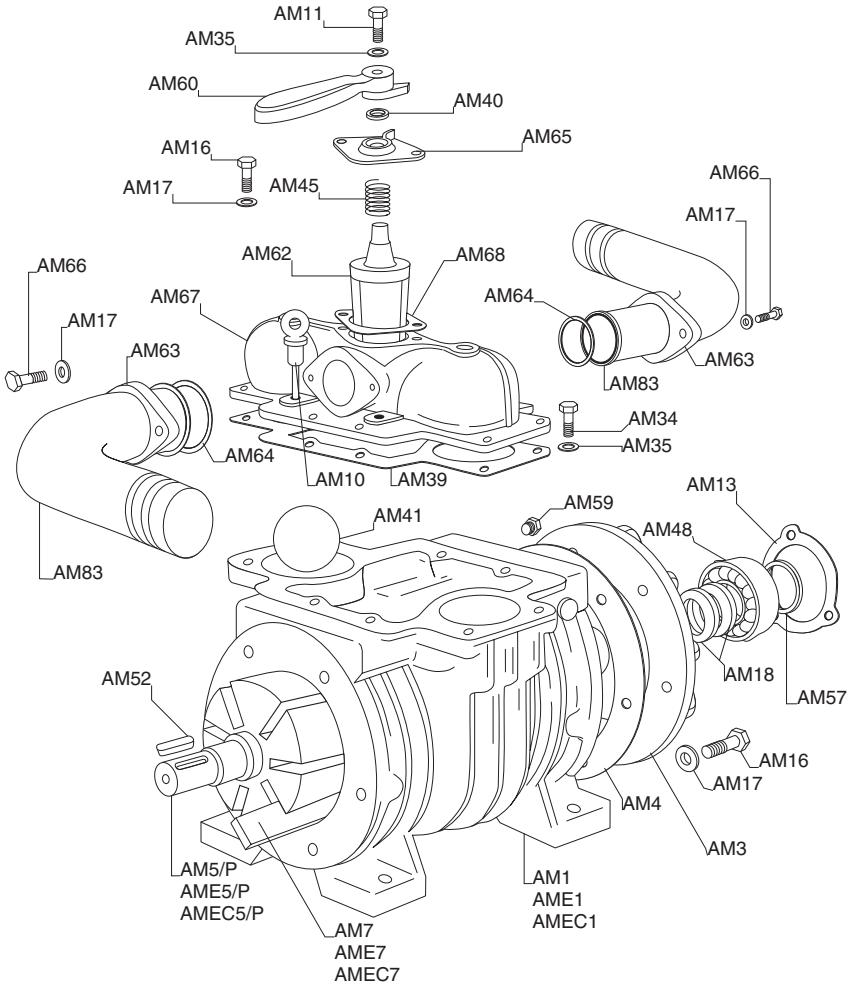

MEC 8000 Ballast Check Valve Assembly

MEC 8000

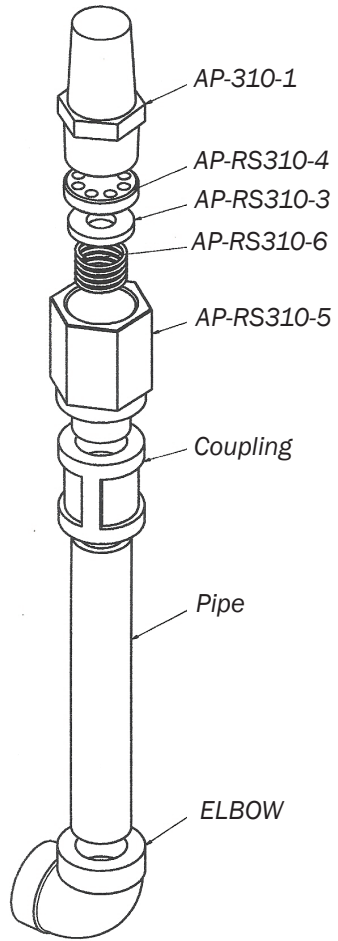

Part #	Description
AP-310-1	Filter, 3/4" NPT
AP-RS310-4	Vent
AP-RS310-3	Washer
AP-RS310-6	Spring
AP-RS310-5	Body, Ballast Port Check
Coupling	Coupling - 1/2" NPT
Pipe	Pipe Nipple, 1/2" NPT x 5"
Elbow	Elbow - 90 Deg 1/2" NPT

Automatic Lubrication System

MEC 5000/PAL

See Parts Diagram opposite.

Part #	Description
AM13	Gasket
AM49	Fitting
LA1	Bearing Cover - MEC 5000/P
LA11	Hose (4mm x 6mm x 9.5")
LA13	Hose (2 mm x 4 mm x 18.5")
LW32CD	Piston Lubricator - Single Outlet (Clockwise)
LW32CS	Piston Lubricator - Single Outlet (Counterclockwise)
LF8	Drive Tab
R3	Fitting
R15	Fitting
R31	Gasket
R33	Washer
R34	Bolt
R36	Fitting
R37	Fitting
R46	Fitting

Detail
Automatic Lubrication System
MEC 5000/PAL

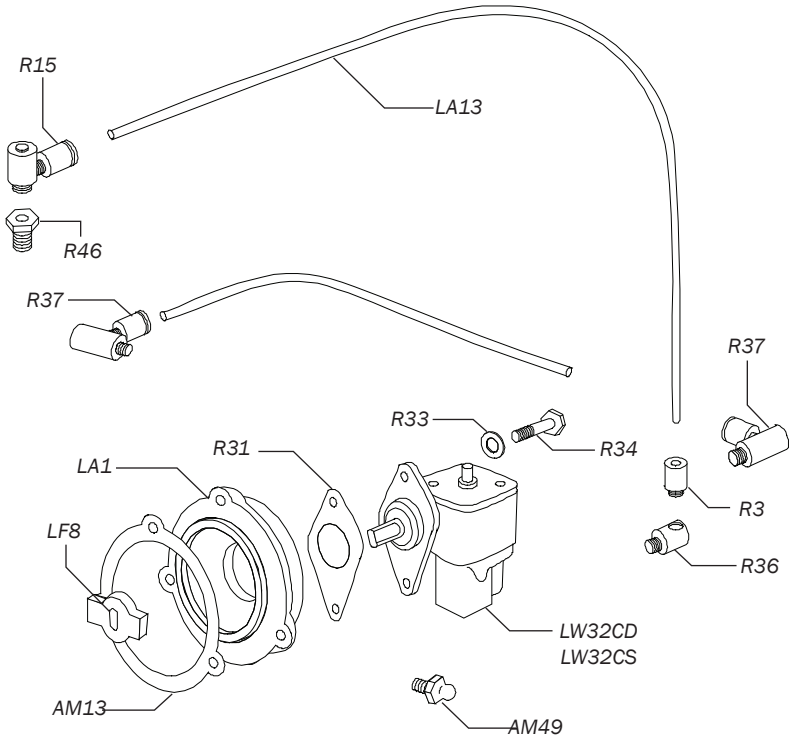

Automatic Lubrication System

MEC 6500/PAL

MEC 8000/PAL

See Parts Diagram opposite.

Part #	Description
AM13	Gasket
AM49	Fitting
LB1	Bearing Cover - MEC 6500/P, MEC 8000/P
LB8	Screw
LB11	Hose (4mm x 6mm x 10.25")
LB16	Hose (2mm x 4mm x 27.25")
LB17	Hose (2mm x 4mm x 11.5")
LB18	Clip
LF8	Drive Tab
LW32D	Piston Lubricator - Double Outlet (Clockwise)
LW32S	Piston Lubricator - Double Outlet (Counterclockwise)
R3	Fitting
R15	Fitting
R31	Gasket
R33	Washer
R34	Bolt
R35	Fitting
R36	Fitting
R37	Fitting
R37-1	Fitting

Detail
Automatic Lubrication System
MEC 6500/PAL • MEC 8000/PAL

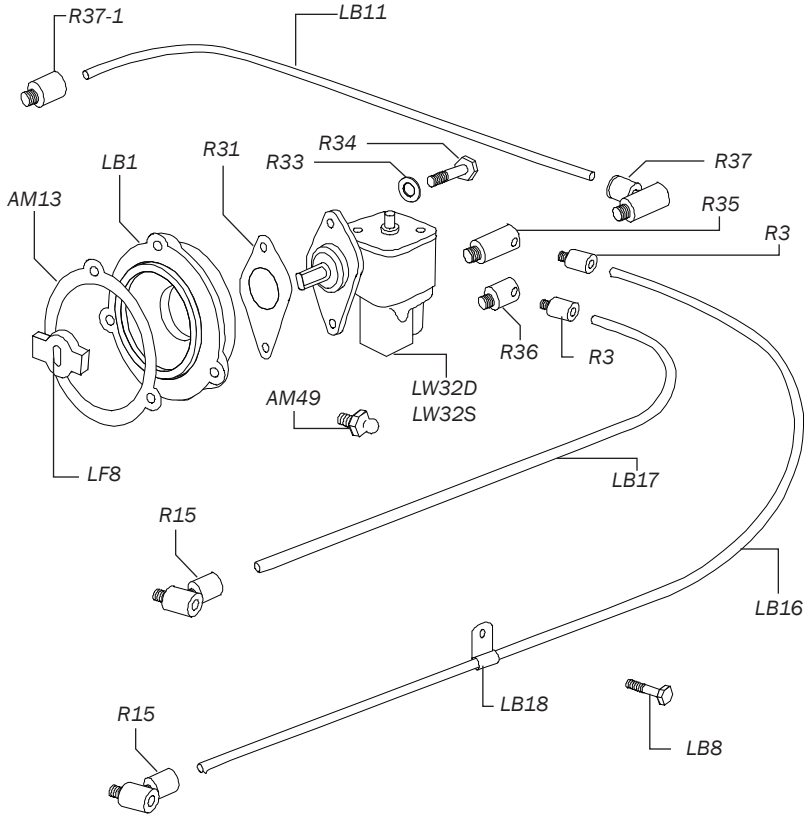

Automatic Oil Pump

See Parts Diagram opposite.

Part #	Description
P 1CW	Pump Body – 1 outlet (Clockwise)
P 1CCW	Pump Body – 1 outlet (Counterclockwise)
P 2CW	Pump Body – 2 outlet (Clockwise)
P 2CCW	Pump Body – 2 outlet (Counterclockwise)
P 5	Driven Gear (Clockwise)
PA 5	Driven Gear (Counterclockwise)
P 6	Spring
P 7CW	Driving Gear (Clockwise)
P 7CCW	Driving Gear (Counterclockwise)
P 8	Seal
P 9	Plug
P 10	Retainer
P 11	Adjusting Screw
P 12	Gasket
P 13	Lid
P 14	Screw
P 15	Jam Nut
P 16	Cap

Detail

Automatic Oil Pump

One & Two Outlet Type

- Part # LW32CD Clockwise - One Outlet
- Part # LW32CS Counterclockwise - One Outlet
- Part # LW32D Clockwise - Two Outlets
- Part # LW32S Counterclockwise - Two Outlets

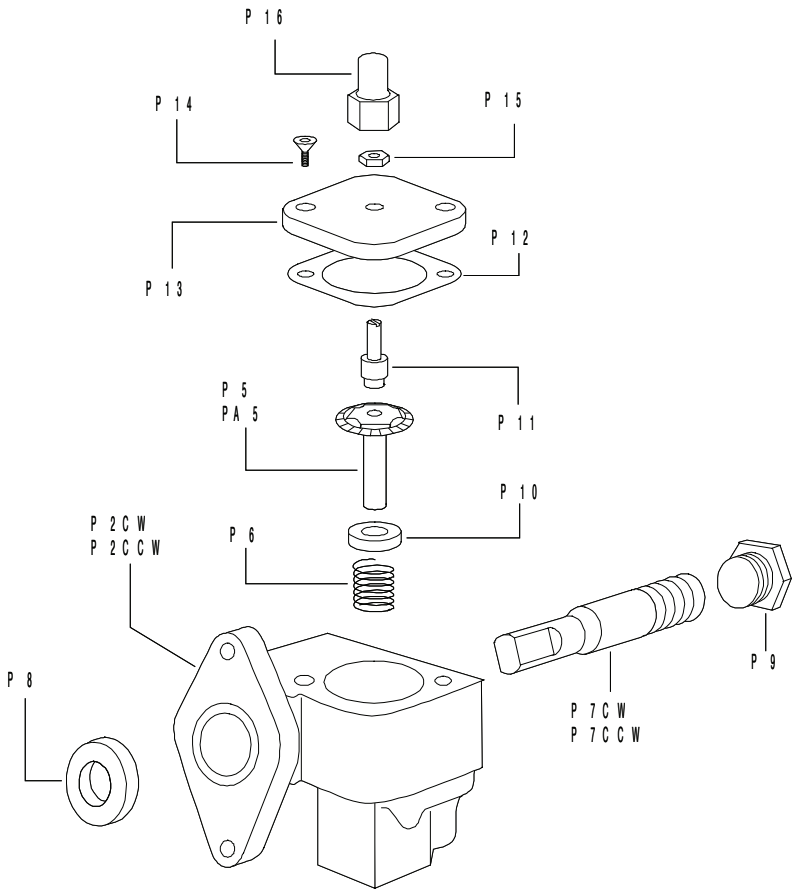

Gear-Type Lubrication System

MEC 5000/P

MEC 6500/P

MEC 8000/P

See Parts Diagram opposite.

Part #	Description
AM13	Gasket
LF1	Cover Plate
LF2	Cover Plate Gasket
LF3	Drive Gear
LF4	Driven Gear
LF6	Bolt
LF7	Oil Pump Housing
LF8	Drive Tab
LF12	Dripper – T-Type (Clockwise)
LF12CCW	Dripper – V-Type (Counterclockwise)
LF12G	Dripper Gasket
LF12GL	Dripper Glass
LF13	Fitting (Housing Oil Reservoir - M10 x 1)
LF15	Hose (5mm x 10.5 mm x 6.75")
LF17	Fitting (Gear Type Oil Pump - M6 x 1)
LF19	Hose (5mm x 10.5 mm x 8.5")
LF20	Hose (5mm x 10.5 mm x 18.5")
LF21	Oil Line Per Foot
LF22	Oil Pump – Complete

Detail

Gear-Type Lubrication System

MEC 5000/P • MEC 6500/P • MEC 8000/P

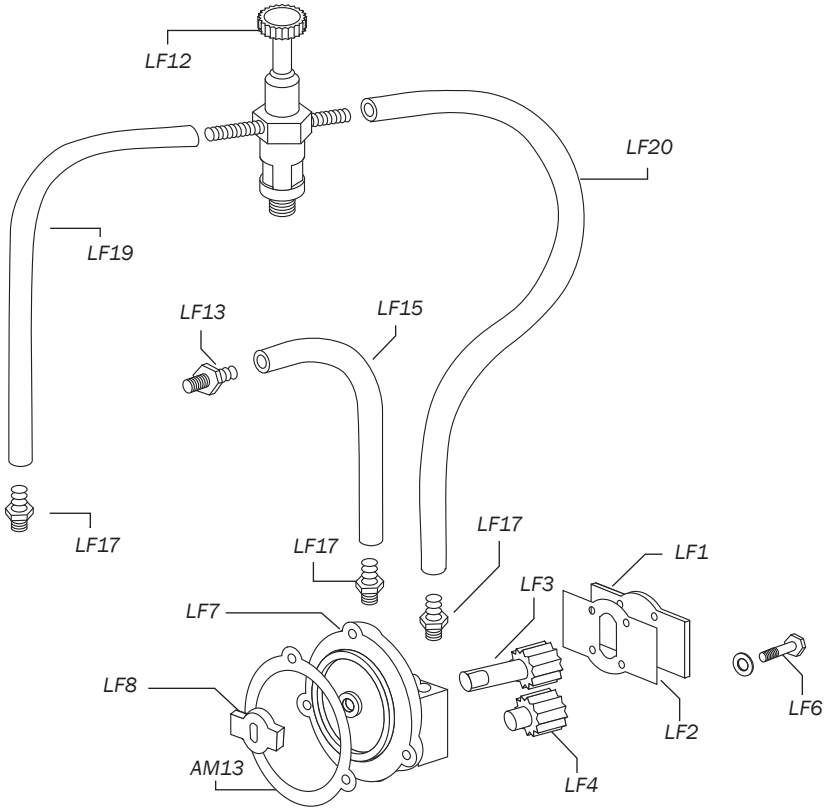

WARRANTY REGISTRATION

Model #: _____ Serial #: _____

Business Name: _____

Address: _____ Telephone: _____

City: _____ State: _____ Zip: _____

Date Purchased: _____ Tank Size: _____

Purchased From: _____

Is this your first National Vacuum Equipment pump purchase? YES NO

Previous pump used? _____

Intended use: Agricultural Septic Commercial Industrial Other _____

Comments: _____



NO POSTAGE
NECESSARY IF
MAILED IN THE
UNITED STATES

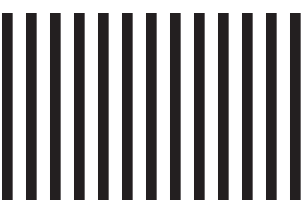

BUSINESS REPLY MAIL

FIRST CLASS PERMIT NO. 146

TRAVERSE CITY, MI

POSTAGE WILL BE PAID BY ADDRESSEE

NATIONAL VACUUM EQUIPMENT, INC.

P.O. BOX 685

TRAVERSE CITY, MI 49685-0685

NVE

National Vacuum Equipment, Inc.

2670 Aero Park Drive
Traverse City, MI 49686 USA

231.941.0215 Phone
231.941.2354 Fax

nve@natvac.com | www.natvac.com | 800.253.5500